

ECONOFROST

Magnet Cassette Night Cover

Introducing the innovative new retractable refrigeration night cover by Econofrost, the 4000 Series Retrofit Magnet Cassette. This design was developed based on customer requests for quick installation on refrigerated display cases using Magnet fasteners. Covering the multi-deck displays increases energy-savings and safeguards fresh foods from warm air, radiation, dust, and insects during closed or slow hours.

The Magnet Cassette is easy to install and boasts the unique feature of being removable when needed. With all the quality features of Econofrost night covers, it ensures product integrity, lowers utility bills, and improves energy efficiency. It can also be installed with screws to be fixed in place like other Econofrost night cover models.

Available in standard and custom sizes, it's the ultimate solution for supermarkets, food service operators and specialty food stores seeking optimal performance and savings with open refrigerated food display cabinet cases.

Included

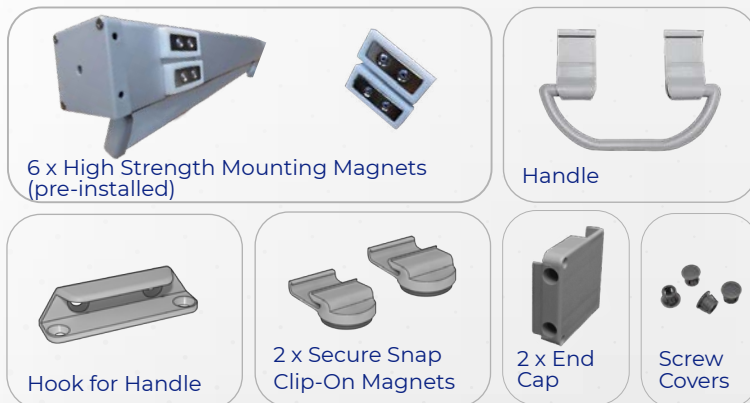

Specifications North American

Model Type: Retrofit Cassette

Fabric Type: Woven Aluminum; Perforated; Silver/Silver Foil Sealed with Polyethylene Reinforced Fibre Edges

Anti-Bacterial: Engineered Solution
Fabric Length: 2000 mm

Handle: Clip-on handle

Sizes: 47-5/8" wide (1210 mm)

Housing: Recyclable Extruded Aluminum Cassette Cover

Mounting System: Acrylic PVC End-Caps with screw holes (and cap covers)

Braking System: Counter-Torsion Spring/Brake Mechanism

Retension: Factory Preset Tension - Easy Adjustment -

Bottom Rail Profile: Recyclable Extruded Aluminum (30 mm)

Optional: Hook (for handle) in lieu of magnets on bottom rail to hold down cover at night

Item Numbers:
41104M - NA size 47-5/8" (1210 mm)

EAE2308 MagnetCassette

ECONO FROST

REFRIGERATION NIGHT COVERS

Installation Instructions

4000 Series Magnet Cassette

OVERVIEW

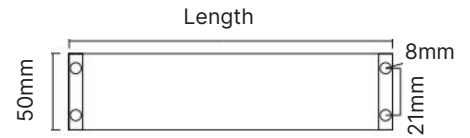
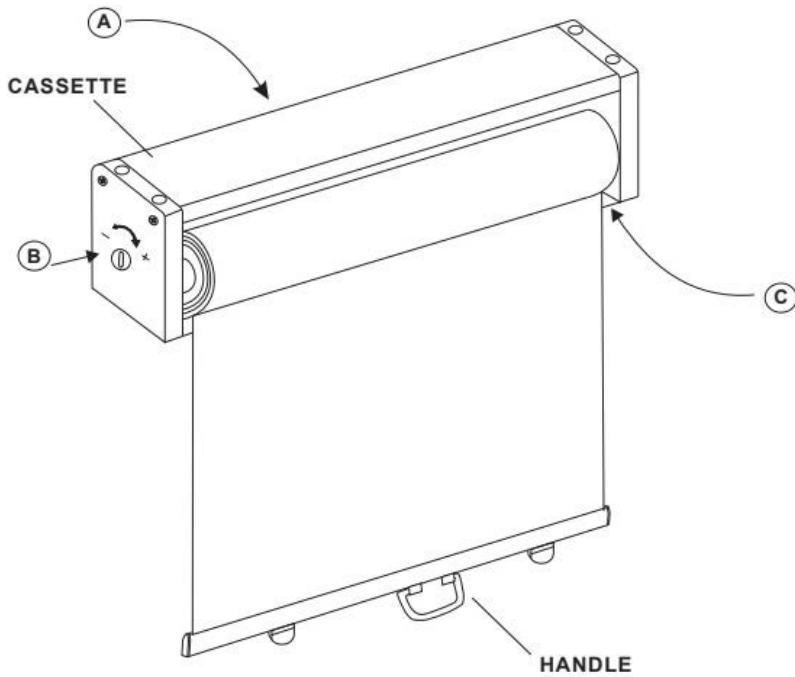

A: FRONT

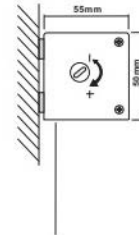

B: SIDE

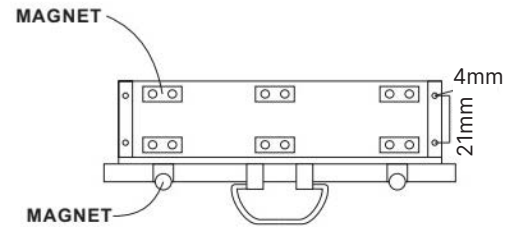

C: BOTTOM

12mm
40mm
Magnet Size

INSTALLATION

METHOD 1

Magnet Installation
Affix the magnets gently to the case canopy.

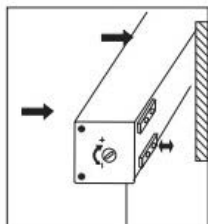

METHOD 2

Screw Installation
(front install) Affix screws through their appropriate holes.

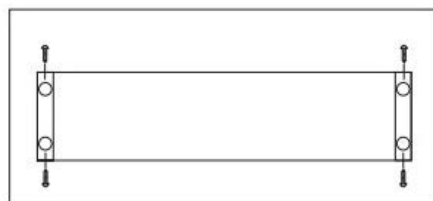

Fabric Retraction Speed
By adjusting the screw on the side you can control the retraction speed.

