

ECONO FROST

Service Case Cassette Night Cover

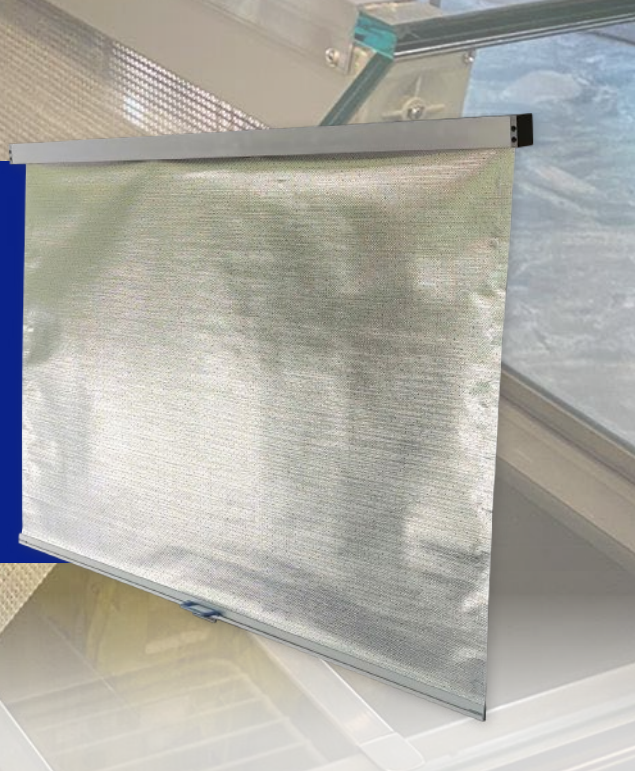

Introducing the innovative new retractable refrigeration night cover by Econofrost, the 3000 Series Retrofit Cassette. This design was developed based on customer requests to enhance refrigerated service cases and displays of any length and widths up to 30" (800 mm) for energy-saving purposes and to safeguard fresh foods from warm air, radiation, dust, and insects during closed or slow hours.

The compact cassette is easy to install and boasts the unique feature of being removable when needed. With all the quality features of Econofrost night covers, it ensures product integrity, lowers utility bills, and improves energy efficiency.

Available in standard and custom sizes, it's the ultimate solution for supermarkets, food service operators and specialty food stores seeking optimal performance and savings with open refrigerated food display cabinet cases.

Included

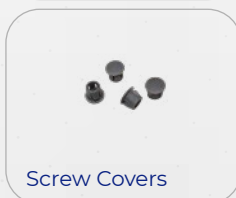

Specifications North American

Model Type: Retrofit Cassette

Fabric Type: Woven Aluminum; Perforated; Silver/Silver Foil Sealed with Polyethylene Reinforced Fibre Edges

Anti-Bacterial: Engineered Solution Fabric Length: 30" (80cm)

Handle: Rigid Fitted handle with integrated fitted hook for securing with fitted hook-for-handle part

Sizes: 23-5/8" (600m), 35-5/8" (905mm), 47-5/8" (1210mm) width

Housing: Recyclable Extruded Aluminum Cassette Cover

Mounting System: Removable Mounting Clip or Acrylic PVC End-Caps (with cap covers)

Braking System: Counter-Torsion Spring/Brake Mechanism

Retension: Factory Preset Tension - Easy Adjustment -

Bottom Rail Profile: Recyclable Extruded Aluminum (25mm)

Optional: Hook (for handle) in lieu of magnets

EAE2308 ServiceCase

Installation Instructions

3000 Service Case Cassette

OVERVIEW

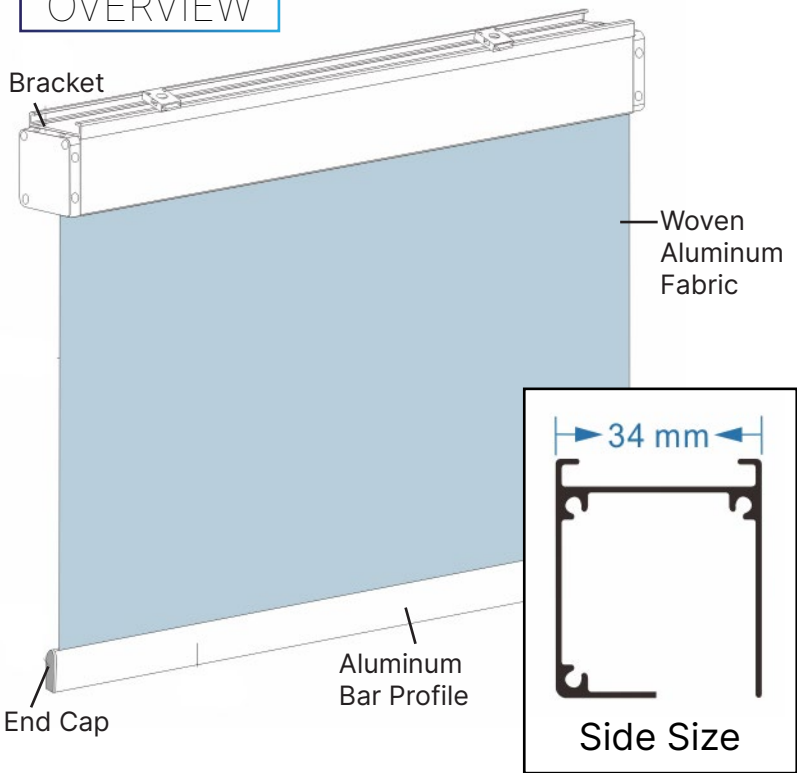

METHOD 1

SIDE VIEW
Top Structure Situation A

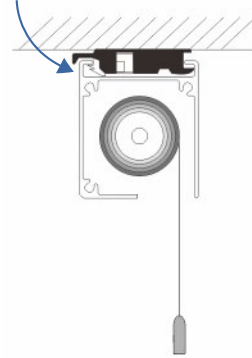

SIDE VIEW
Top Structure Situation B

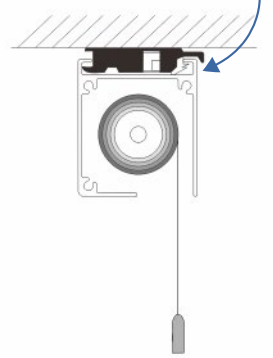

INSTALLATION

Fix the installation clips with screws at both ends of the product frame 40 to 60mm.

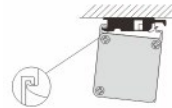
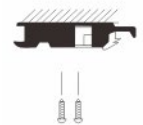

Holding the cassette housing frame with both hands, snap it into the hooks on the outside of the mounting bracket.

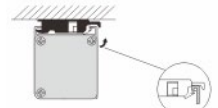

Insert the other side of the frame into the hook of the installation clip in the direction indicated by the arrow in the figure. Upon hearing a click sound, installation is completed.

METHOD 2

SIDE VIEW

Left Structure Situation

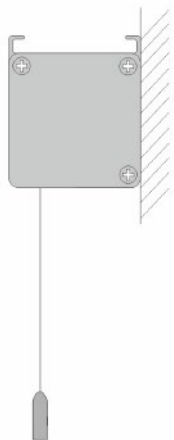

Top Structure Situation

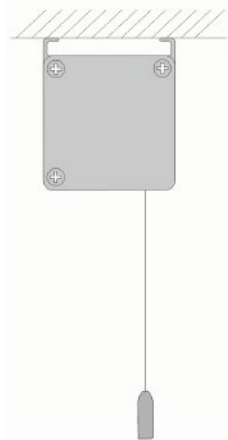

Right Structure Situation

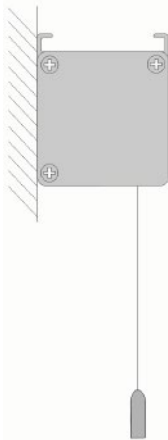

INSTALLATION

Fix the support in the required position using screws. There are three directions to choose from.

